

PRODUCT CODE: CN6
EASYFIT CHANNEL NUT

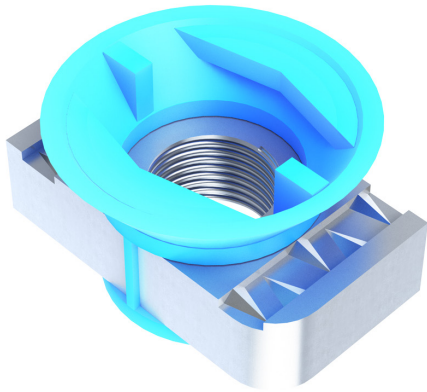

DESCRIPTION

M6 Easyfit Channel Nut

FINISH

Nut: BZP / Easyfit Cone: Blue

MATERIAL

Nut: Steel / Easyfit Cone: Nylon 6

PACKAGING

Packed in qty 100

ADDITIONAL NOTES

Produced to comply with the requirements of BS6946 Metal Channel Support Systems
For use with 21mm and 41mm Depth Channel

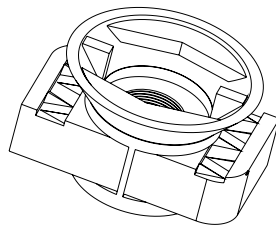

Isometric view

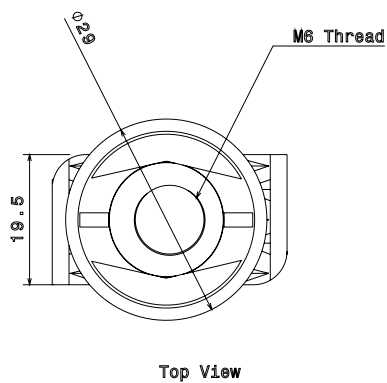

Top View

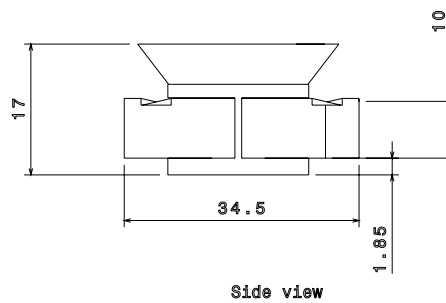

Side view